



Adjustable open-ended spanner, metric

4025



Art.No. 40250104
GTIN 4018754299492
Model 4025 4

Label. Adjustable open-ended spanner max. spanner size 13mm L.115mm

- Features.**
- right-handed
 - DIN 3117/ISO 6787 (B shape)
 - ASME B107.100
 - jaw offset 22.5°
 - Chrome Vanadium, chrome plated

Advantages.

Right-handed.

Technical Drawing.

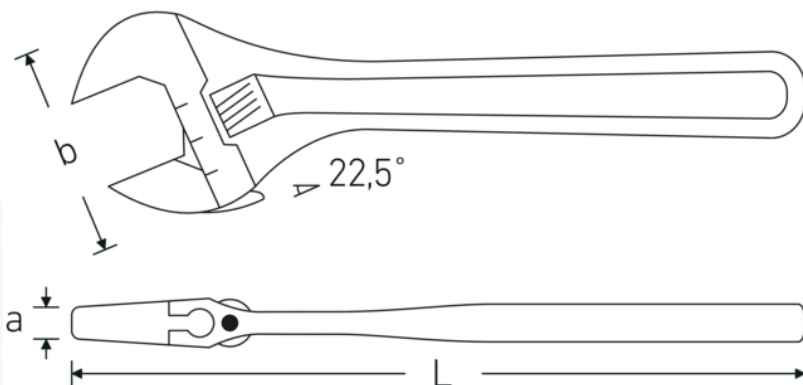

Technical Attributes.

a	9,5 mm
Width mm (b)	35 mm
Size	4
Length mm (L)	115 mm
Schlüsselweite max. [mm]	13 mm

Logistics data.

Depth mm (IFS)	115
Width mm (IFS)	32
Height mm (IFS)	9
Length (packed, mm)	117
Width (packed, mm)	38
Height (packed, mm)	39
Volume (packed, dm3)	0.173394 dm3
Art. no.	40250104
Weight (gross, kg)	0,275
Weight PAP (kg)	0,000
Weight PVC (kg)	0,007
GTIN	4018754299492
Country of origin	SPAIN
Region of origin	Ausländischer Ursprung
WEEE/ElektroG	nicht ear-pflichtig
Customs tariff no.	82041200
Packing standard	5
Weight	52 g

Variants.

Art. no.	Art. no. (ERP)	Description	GTIN
40250104	4025 4	Adjustable open-ended spanner max. spanner size 13mm L.115mm	4018754299492
40250106	4025 6	Adjustable open-ended spanner max. spanner size 24mm L.161mm	4018754299508
40250108	4025 8	Adjustable open-ended spanner max. spanner size 30mm L.207mm	4018754299515
40250110	4025 10	Adjustable open-ended spanner max. spanner size 34mm L.259mm	4018754299522
40250112	4025 12	Adjustable open-ended spanner max. spanner size 39mm L.311mm	4018754299539
40250115	4025 15	Adjustable open-ended spanner max. spanner size 44mm L.386mm	4018754299546
40250118	4025 18	Adjustable open-ended spanner max. spanner size 53mm L.462mm	4018754299553

GTIN-Code.



STAHLWILLE Eduard Wille GmbH & Co. KG

Lindenallee 27 · 42349 Wuppertal · Germany · Phone: +49 202 4791-0 · Fax: +49 202 4791-200
info@stahlwille.de · www.stahlwille.com · Copyright by STAHLWILLE Eduard Wille GmbH & Co. KG, Wuppertal
Copyright by STAHLWILLE Eduard Wille GmbH & Co. KG, Wuppertal