



Pulling device

11501

Art.No. 71050101
GTIN 4018754342266
Model 11501/1 Abziehvorrichtung zu
Trennvorr.

Label.

Pull-off device

Features.

- galvanised
- fits No. 11500 of the same size
- for pulling off ball bearings, roller bearings, bushings, wheels and other tight-fitting parts
- the puller connects to the No. 11500 separator and the workpiece can be pulled off

Advantages.

high stability when pulling off, as separator and puller are firmly screwed together.

The fixed bolting of the separator to the puller provides high stability.

Makes reliable and fast extraction of tight fitting ball bearings, bushings, oil seals etc. possible.

Strong spindle with fine thread for outstanding precision and load capacity.

Product highlights.



For improved safety.

Designed with practical applications in mind, drop forged, precision machined on the latest machine tools, hardened and tempered: the STAHLWILLE puller range offers numerous products for a wide variety of applications. For example, standard pullers, cell terminal pullers, ejectors, counter stays, ball joint pullers and wheel hub pullers. Made, of course, in Germany as premium quality tools.

Technical Drawing.

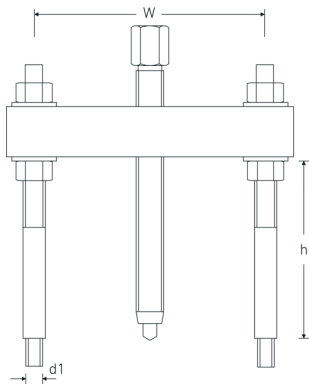

Technical Attributes.

External hex drive (mm)	17 mm
Connection thread	M10
for no.	11500/1
Size	1
Clamping range mm (w)	40-120 mm
Clamping depth (h) mm	125 mm
Spindle thread size	M14 x 120

Logistics data.

Depth mm (IFS)	195
Width mm (IFS)	160
Height mm (IFS)	60
Length (packed, mm)	195
Width (packed, mm)	160
Height (packed, mm)	60
Volume (packed, dm3)	1.872 dm3
Art. no.	71050101
Weight (gross, kg)	1,118
Weight PAP (kg)	0,004
Weight PVC (kg)	0,000
GTIN	4018754342266
Country of origin	GERMANY
Region of origin	Nordrhein-Westfalen
WEEE/ElektroG	nicht ear-pflichtig
Customs tariff no.	82055980
Packing standard	1
Weight	1000 g

Variants.

Art. no.	Art. no. (ERP)	Description	GTIN
71050101	11501/1 Abziehvorrichtung zu Trennvorr.	Pull-off device	4018754342266

71050102	11501/2 Abziehvorrichtung zu Trennvorr.	Pull-off device	4018754342273
71050103	11501/3 Abziehvorrichtung zu Trennvorr.	Pull-off device	4018754342280
71050104	11501/4 Abziehvorrichtung zu Trennvorr.	Pull-off device	4018754342297

GTIN-Code.



Accessories.



71050016
Separating device



71050201
Extension

Images.





STAHLWILLE Eduard Wille GmbH & Co. KG

Lindenallee 27 · 42349 Wuppertal · Germany · Phone: +49 202 4791-0 · Fax: +49 202 4791-200
info@stahlwille.de · www.stahlwille.com · Copyright by STAHLWILLE Eduard Wille GmbH & Co. KG, Wuppertal
Copyright by STAHLWILLE Eduard Wille GmbH & Co. KG, Wuppertal