



Ring insert tool

732/10

Art.No. 58221008
GTIN 4018754034062
Model 732/10 8



Label. Ring insert tool Spanner size 8mm Tool holders 9 x 12

- Features.**
- For square drive torque wrenches
 - Fixation by pin lock
 - Chromium over nickel, durable and chip-proof finish
 - Drop-forged, hardened and cooled in oil bath
 - Extremely resilient, exceptionally durable

Advantages.

For torque wrench with square drive.

Technical Drawing.

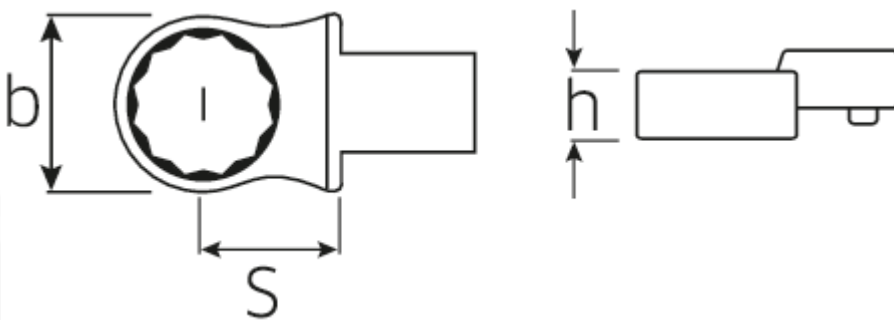

Technical Attributes.

Width mm (b)	14,2 mm
Size square socket [inside square drive]	9 x 12 mm
Height mm (h)	8 mm
S	17,5 mm
Width across flats [mm]	8 mm

Logistics data.

Depth mm (IFS)	41
Width mm (IFS)	22
Height mm (IFS)	14
Length (packed, mm)	47
Width (packed, mm)	25
Height (packed, mm)	15
Volume (packed, dm3)	0.017625 dm3
Art. no.	58221008
Weight (gross, kg)	0,040
Weight PAP (kg)	0,000
Weight PVC (kg)	0,002
GTIN	4018754034062
Country of origin	GERMANY
Region of origin	Nordrhein-Westfalen
WEEE/ElektroG	nicht ear-pflichtig
Customs tariff no.	82041100
Packing standard	1
Weight	40 g

Variants.

Art. no.	Art. no. (ERP)	Description	GTIN
58221007	732/10 7	Ring insert tool Spanner size 7mm Tool holders9 x 12	4018754034055
58221008	732/10 8	Ring insert tool Spanner size 8mm Tool holders9 x 12	4018754034062
58221010	732/10 10	Ring insert tool Spanner size 10mm Tool holders9 x 12	4018754034079
58221011	732/10 11	Ring insert tool Spanner size 11mm Tool holders9 x 12	4018754034086
58221012	732/10 12	Ring insert tool Spanner size 12mm Tool holders9 x 12	4018754034093
58221013	732/10 13	Ring insert tool Spanner size 13mm Tool holders9 x 12	4018754034109
58221014	732/10 14	Ring insert tool Spanner size 14mm Tool holders9 x 12	4018754034116
58221015	732/10 15	Ring insert tool Spanner size 15mm Tool holders9 x 12	4018754034123

58221016	732/10 16	Ring insert tool Spanner size 16mm Tool holders9 x 12	4018754034130
58221017	732/10 17	Ring insert tool Spanner size 17mm Tool holders9 x 12	4018754034147
58221018	732/10 18	Ring insert tool Spanner size 18mm Tool holders9 x 12	4018754034154
58221019	732/10 19	Ring insert tool Spanner size 19mm Tool holders9 x 12	4018754034161
58221021	732/10 21	Ring insert tool Spanner size 21mm Tool holders9 x 12	4018754034178
58221022	732/10 22	Ring insert tool Spanner size 22mm Tool holders9 x 12	4018754034185

GTIN-Code.



STAHLWILLE Eduard Wille GmbH & Co. KG

Lindenallee 27 · 42349 Wuppertal · Germany · Phone: +49 202 4791-0 · Fax: +49 202 4791-200
info@stahlwille.de · www.stahlwille.com · Copyright by STAHLWILLE Eduard Wille GmbH & Co. KG, Wuppertal
Copyright by STAHLWILLE Eduard Wille GmbH & Co. KG, Wuppertal