



## Ring insert tool

**732/40**

Art.No. **58224017**  
GTIN **4018754034239**  
Model **732/40 17**



### Label.

Ring insert tool Spanner size 17mm Tool holders 14 x 18

### Features.

- For square drive torque wrenches
- Fixation by pin lock
- Chromium over nickel, durable and chip-proof finish
- Drop-forged, hardened and cooled in oil bath
- Extremely resilient, exceptionally durable

## Advantages.

For torque wrench with square drive.

## Technical Drawing.

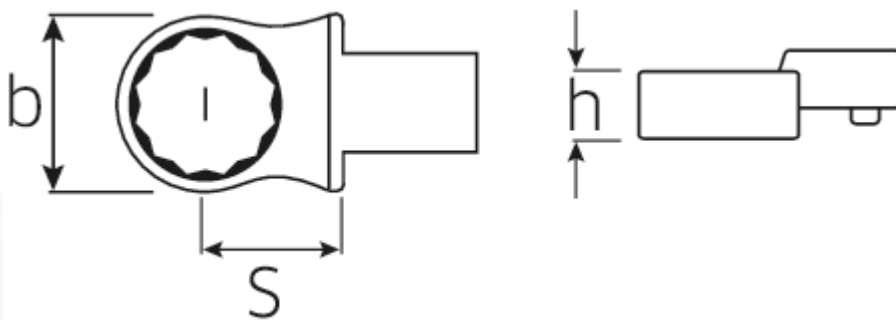

## Technical Attributes.

Width mm (b)	27 mm
Size square socket [inside square drive]	14 x 18 mm
Height mm (h)	12 mm
S	25 mm
Width across flats [mm]	17 mm

## Logistics data.

Depth mm (IFS)	64
Width mm (IFS)	30
Height mm (IFS)	21
Length (packed, mm)	70
Width (packed, mm)	33
Height (packed, mm)	22
Volume (packed, dm3)	0.05082 dm3
Art. no.	58224017
Weight (gross, kg)	0,138
Weight PAP (kg)	0,000
Weight PVC (kg)	0,002
GTIN	4018754034239
Country of origin	GERMANY
Region of origin	Nordrhein-Westfalen
WEEE/ElektroG	nicht ear-pflichtig
Customs tariff no.	82041100
Packing standard	1
Weight	135 g

## Variants.

Art. no.	Art. no. (ERP)	Description	GTIN
58224013	732/40 13	Ring insert tool Spanner size 13mm Tool holders14 x 18	4018754034192
58224014	732/40 14	Ring insert tool Spanner size 14mm Tool holders14 x 18	4018754034208
58224015	732/40 15	Ring insert tool Spanner size 15mm Tool holders14 x 18	4018754034215
58224016	732/40 16	Ring insert tool Spanner size 16mm Tool holders14 x 18	4018754034222
58224017	732/40 17	Ring insert tool Spanner size 17mm Tool holders14 x 18	4018754034239
58224018	732/40 18	Ring insert tool Spanner size 18mm Tool holders14 x 18	4018754034246
58224019	732/40 19	Ring insert tool Spanner size 19mm Tool holders14 x 18	4018754034253
58224021	732/40 21	Ring insert tool Spanner size 21mm Tool holders14 x 18	4018754034260

58224022	732/40 22	Ring insert tool Spanner size 22mm Tool holders14 x 18	4018754034277
58224024	732/40 24	Ring insert tool Spanner size 24mm Tool holders14 x 18	4018754034284
58224027	732/40 27	Ring insert tool Spanner size 27mm Tool holders14 x 18	4018754034291
58224028	732/40 28	Ring insert tool Spanner size 28mm Tool holders14 x 18	4018754162307
58224030	732/40 30	Ring insert tool Spanner size 30mm Tool holders14 x 18	4018754034307
58224032	732/40 32	Ring insert tool Spanner size 32mm Tool holders14 x 18	4018754034314
58224034	732/40 34	Ring insert tool Spanner size 34mm Tool holders14 x 18	4018754034321
58224036	732/40 36	Ring insert tool Spanner size 36mm Tool holders14 x 18	4018754034338
58224041	732/40 41	Ring insert tool Spanner size 41mm Tool holders14 x 18	4018754034345

## GTIN-Code.



### STAHLWILLE Eduard Wille GmbH & Co. KG

Lindenallee 27 · 42349 Wuppertal · Germany · Phone: +49 202 4791-0 · Fax: +49 202 4791-200  
info@stahlwille.de · www.stahlwille.com · Copyright by STAHLWILLE Eduard Wille GmbH & Co. KG, Wuppertal  
Copyright by STAHLWILLE Eduard Wille GmbH & Co. KG, Wuppertal