



Ring insert tool

732a/10

Art.No. **58621024**
GTIN **4018754035076**
Model **732A/10 3/8**



Label.

Ring insert tool Spanner size 3/8" Tool holders 9 x 12

Features.

- For square drive torque wrenches
- Fixation by pin lock
- Chromium over nickel, durable and chip-proof finish
- Drop-forged, hardened and cooled in oil bath
- Extremely resilient, exceptionally durable

Advantages.

For torque wrench with square drive.

Technical Drawing.

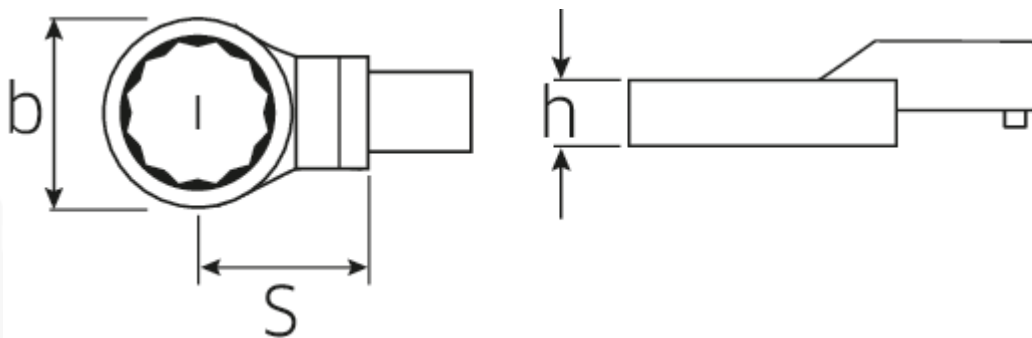

Technical Attributes.

Width mm (b)	17,2 mm
Size square socket [inside square drive]	9 x 12 mm
Height mm (h)	9 mm
S	17,5 mm
Spanner size [inch]	3/8 "

Logistics data.

Depth mm (IFS)	41
Width mm (IFS)	23
Height mm (IFS)	14
Length (packed, mm)	47
Width (packed, mm)	26
Height (packed, mm)	15
Volume (packed, dm3)	0.01833 dm3
Art. no.	58621024
Weight (gross, kg)	0,040
Weight PAP (kg)	0,000
Weight PVC (kg)	0,002
GTIN	4018754035076
Country of origin	GERMANY
Region of origin	Nordrhein-Westfalen
WEEE/ElektroG	nicht ear-pflichtig
Customs tariff no.	82041100
Packing standard	1
Weight	37 g

Variants.

Art. no.	Art. no. (ERP)	Description	GTIN
58621016	732A/10 1/4	Ring insert tool Spanner size 1/4" Tool holders9 x 12	4018754035052
58621020	732A/10 5/16	Ring insert tool Spanner size 5/16" Tool holders9 x 12	4018754035069
58621024	732A/10 3/8	Ring insert tool Spanner size 3/8" Tool holders9 x 12	4018754035076
58621028	732A/10 7/16	Ring insert tool Spanner size 7/16" Tool holders9 x 12	4018754035083
58621032	732A/10 1/2	Ring insert tool Spanner size 1/2" Tool holders9 x 12	4018754035090
58621034	732A/10 9/16	Ring insert tool Spanner size 9/16" Tool holders9 x 12	4018754035106
58621036	732A/10 5/8	Ring insert tool Spanner size 5/8" Tool holders9 x 12	4018754035113
58621038	732A/10 11/16	Ring insert tool Spanner size 11/16" Tool holders9 x 12	4018754035120

58621040	732A/10 3/4	Ring insert tool Spanner size 3/4" Tool holders9 x 12	4018754035137
58621042	732A/10 13/16	Ring insert tool Spanner size 13/16" Tool holders9 x 12	4018754035144
58621044	732A/10 7/8	Ring insert tool Spanner size 7/8" Tool holders9 x 12	4018754035151

GTIN-Code.



STAHLWILLE Eduard Wille GmbH & Co. KG

Lindenallee 27 · 42349 Wuppertal · Germany · Phone: +49 202 4791-0 · Fax: +49 202 4791-200
info@stahlwille.de · www.stahlwille.com · Copyright by STAHLWILLE Eduard Wille GmbH & Co. KG, Wuppertal
Copyright by STAHLWILLE Eduard Wille GmbH & Co. KG, Wuppertal