



Ring insert tool

732/100

Art.No. **58221030**
GTIN **4018754238774**
Model **732/100 SW 30**



Label.

Ring insert tool Spanner size 30mm Tool holders 22 x 28

Features.

- For square drive torque wrenches
- Fixation by pin lock
- Chromium over nickel, durable and chip-proof finish
- Drop-forged, hardened and cooled in oil bath
- Extremely resilient, exceptionally durable

Advantages.

For torque wrench with square drive.

Technical Drawing.

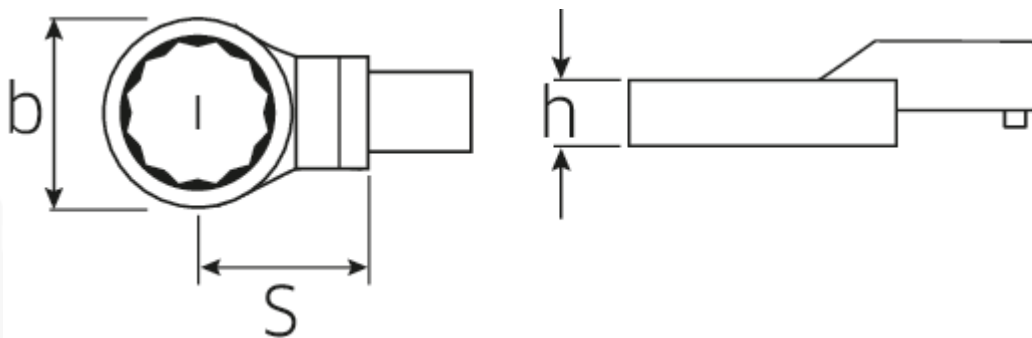

Technical Attributes.

Width mm (b)	46 mm
Size square socket [inside square drive]	22 x 28 mm
Height mm (h)	16 mm
S	55 mm
Width across flats [mm]	30 mm

Logistics data.

Depth mm (IFS)	121
Width mm (IFS)	43
Height mm (IFS)	32
Length (packed, mm)	165
Width (packed, mm)	75
Height (packed, mm)	35
Volume (packed, dm3)	0.433125 dm3
Art. no.	58221030
Weight (gross, kg)	0,625
Weight PAP (kg)	0,000
Weight PVC (kg)	0,005
GTIN	4018754238774
Country of origin	GERMANY
Region of origin	Nordrhein-Westfalen
WEEE/ElektroG	nicht ear-pflichtig
Customs tariff no.	82041100
Packing standard	1
Weight	617 g

Variants.

Art. no.	Art. no. (ERP)	Description	GTIN
58221024	732/100 SW 24	Ring insert tool Spanner size 24mm Tool holders22 x 28	4018754238750
58221027	732/100 SW 27	Ring insert tool Spanner size 27mm Tool holders22 x 28	4018754238767
58221030	732/100 SW 30	Ring insert tool Spanner size 30mm Tool holders22 x 28	4018754238774
58221032	732/100 SW 32	Ring insert tool Spanner size 32mm Tool holders22 x 28	4018754238781
58221034	732/100 SW 34	Ring insert tool Spanner size 34mm Tool holders22 x 28	4018754238798
58221036	732/100 SW 36	Ring insert tool Spanner size 36mm Tool holders22 x 28	4018754238804
58221041	732/100 SW 41	Ring insert tool Spanner size 41mm Tool holders22 x 28	4018754238811
58221046	732/100 SW 46	Ring insert tool Spanner size 46mm Tool holders22 x 28	4018754238828

58221050	732/100 SW 50	Ring insert tool Spanner size 50mm Tool holders22 x 28	4018754238835
58221055	732/100 SW 55	Ring insert tool Spanner size 55mm Tool holders22 x 28	4018754238842
58221060	732/100 SW 60	Ring insert tool Spanner size 60mm Tool holders22 x 28	4018754238859

GTIN-Code.



STAHLWILLE Eduard Wille GmbH & Co. KG

Lindenallee 27 · 42349 Wuppertal · Germany · Phone: +49 202 4791-0 · Fax: +49 202 4791-200
info@stahlwille.de · www.stahlwille.com · Copyright by STAHLWILLE Eduard Wille GmbH & Co. KG, Wuppertal
Copyright by STAHLWILLE Eduard Wille GmbH & Co. KG, Wuppertal