



IMPACT socket

2307TX

Art.No. 23070040
GTIN 4018754015238
Model 2307TX IMP T 40

Label. IMPACT socket 1/2 " L.40mm

- Features.**
- 1/2" #a;-drive
 - inside TORX®
 - for power drivers
 - Chrome Alloy Steel, gunmetal finish

Advantages.

1/2" inner square drive.

Product highlights.



Optimized functionality.

All IMPACT sockets have a straight-through central bore for the locking pin and a deep groove for the O-ring to improve grip. The locking pin is not under load during use.

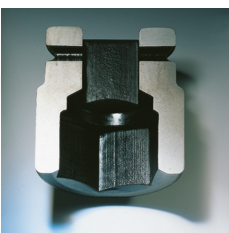

High fitting accuracy.

The remarkable fitting accuracy, which is due to very tight tolerances, guarantees minimum loss of force as the impact is transferred from the impact screwdriver to the socket insert and also guarantees dramatically improved durability.

Technical Drawing.

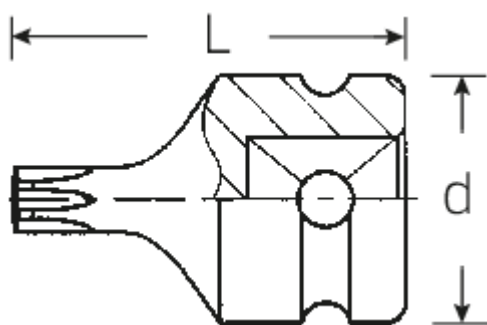

Technical Attributes.

Drive profile	TORX®
TORX® drive profile (mm)	6,6 mm
Internal square drive (inch)	1/2 "
d	25 mm
Size of output profile	T40
Length mm (L)	40 mm

Logistics data.

Depth mm (IFS)	40
Width mm (IFS)	25
Height mm (IFS)	25
Length (packed, mm)	105
Width (packed, mm)	45
Height (packed, mm)	26
Volume (packed, dm3)	0.12285 dm3
Art. no.	23070040
Weight (gross, kg)	0,296
Weight PAP (kg)	0,000
Weight PVC (kg)	0,003
GTIN	4018754015238
Country of origin	GERMANY
Region of origin	Nordrhein-Westfalen
WEEE/ElektroG	nicht ear-pflichtig
Customs tariff no.	82042000
Packing standard	5
Weight	58 g

Variants.

Art. no.	Art. no. (ERP)	Description	GTIN
23070030	2307TX IMP T 30	IMPACT socket 1/2 " L.40mm	4018754015221
23070040	2307TX IMP T 40	IMPACT socket 1/2 " L.40mm	4018754015238
23070045	2307TX IMP T 45	IMPACT socket 1/2 " L.40mm	4018754154012
23070050	2307TX IMP T 50	IMPACT socket 1/2 " L.40mm	4018754015245

23070055	2307TX IMP T 55	IMPACT socket 1/2 " L.40mm	4018754015252
23070060	2307TX IMP T 60	IMPACT socket 1/2 " L.40mm	4018754015269

GTIN-Code.



Accessories.



39022030
Connecting pin



39011940
Rubber rings

STAHLWILLE Eduard Wille GmbH & Co. KG

Lindenallee 27 · 42349 Wuppertal · Germany · Phone: +49 202 4791-0 · Fax: +49 202 4791-200
info@stahlwille.de · www.stahlwille.com · Copyright by STAHLWILLE Eduard Wille GmbH & Co. KG, Wuppertal
Copyright by STAHLWILLE Eduard Wille GmbH & Co. KG, Wuppertal