



Electronic workshop tester SENSOTORK®

7707 W

Art.No. **96521084**
GTIN **4018754181179**
Model **7707-2-2W**



Label.

Electronic workshop tester SENSOTORK® Measuring r.8-400N·m Internal square 3/4"

Features.

Electronic torque tester for torque wrenches, consisting of:

- transducer (patent)
- holder
- display unit (registered design)
- tripod for display unit (with 1.5 m cable)
- spiral cable
- mains adaptor (110 V–230 V with interchangeable socket adaptors) or direct connection to 12 V in-car supply is possible
- square drive adaptor (No 7707-2W, No 7707-2-1W, No 7707-2-2W, No 7707-3W)
- kit for attaching the unit to a workbench or wall in a horizontal or vertical testing position
- for clockwise and anticlockwise use
- units of measurement: N·m, ft·lb, in·lb
- the easily interchangeable transducers are attached to the holder by means of a QuickRelease safety lock
- low lateral forces thanks to low-profile transducers
- automatic detection of the transducer
- flexible and user friendly because the unit can be used horizontally or vertically and the display unit can be placed in many positions
- additional tripod with 1.5 m cable for mounting the display unit to facilitate visual monitoring when using longer torque wrenches
- especially broad measuring range from approx. 2 % to 100 % of rated value
- the software No 7759-4, including USB hub and jack cable, enables readings to be transferred to the PC for documenting (no separate power supply needed, power comes from PC)
- while individual transducers are being recalibrated, the torque tester itself remains on-site for further use
- wide range of application (-20°C to +60°C)
- complies with DIN 51309, Class 2 and DKD-R 10-8
- with certificate
- supplied in sturdy plastic box

QuickRelease Rapid change and firm locking of the transducers thanks to the QuickRelease safety lock.

Interchangeable square drive adaptors: A set of interchangeable square drive adaptors are conveniently stored in the mounting block for a range of different drive sizes.



Technical Drawing.

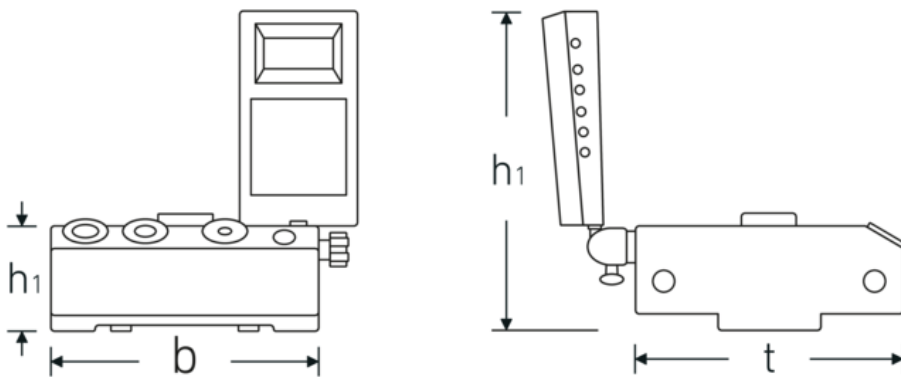

Technical Attributes.

Measuring range N·m	8-400 N·m
Internal square [inch]	3/4 "
Width mm (b)	180 mm
Weight with box	11100 g
Height mm (h)	165 mm
Height mm (h1)	79 mm
Height mm (h2)	215 mm
No.	7707-2-2W
t	180 mm

Logistics data.

Depth mm (IFS)	440
Width mm (IFS)	340
Height mm (IFS)	165
Length (packed, mm)	440
Width (packed, mm)	340
Height (packed, mm)	165
Volume (packed, dm ³)	24.684 dm ³
Art. no.	96521084
Weight (gross, kg)	10,700
Weight PAP (kg)	0,016
Weight PVC (kg)	0,000
GTIN	4018754181179
Country of origin	GERMANY
Region of origin	Nordrhein-Westfalen
WEEE/ElektroG	Kleingeräte B2C

Customs tariff no.	90318080
Packing standard	1
Weight	7654 g

Variants.

Art. no.	Art. no. (ERP)	Description	GTIN
96521086	7707-1-3W	Electronic workshop tester SENSOTORK® Measuring r.0,2-10N·m Internal square 1/4"	4018754241958
96521085	7707-1-2W	Electronic workshop tester SENSOTORK® Measuring r.0,2-10N·m Internal square 1/4"	4018754241941
96521080	7707N-1W	Electronic workshop tester SENSOTORK® Measuring r.0,4-20N·m Internal square 1/4"	4018754181148
96521072	7707-2W	Electronic workshop tester SENSOTORK® Measuring r.2-100N·m Internal square 3/8"	4018754155781
96521083	7707-2-1W	Electronic workshop tester SENSOTORK® Measuring r.4-200N·m Internal square 1/2"	4018754181162
96521084	7707-2-2W	Electronic workshop tester SENSOTORK® Measuring r.8-400N·m Internal square 3/4"	4018754181179
96521082	7707N-3W	Electronic workshop tester SENSOTORK® Measuring r.25-1100N·m Internal square 3/4"	4018754181155

GTIN-Code.



STAHLWILLE Eduard Wille GmbH & Co. KG

Lindenallee 27 · 42349 Wuppertal · Germany · Phone: +49 202 4791-0 · Fax: +49 202 4791-200
info@stahlwille.de · www.stahlwille.com · Copyright by STAHLWILLE Eduard Wille GmbH & Co. KG, Wuppertal
Copyright by STAHLWILLE Eduard Wille GmbH & Co. KG, Wuppertal