



Uniflex sockets spline-drive

402aSP

Art.No. **01542020**
GTIN **4018754170883**
Model **402ASP 10 =5/16**



Label. 1/4" Uniflex sockets spline-drive L.38mm

Features.

- for external spline-drive screws
- MS-33787, MIL-W-8982
- HPQ® high performance steel, chrome plated

Advantages.

For external spline drive screws

STAHLWILLE: For over 160 years, we as a traditional German company from Wuppertal have stood for tools that are appreciated around the world for their excellent quality

Technologies and features.



High Performance Quality (HPQ®)

High-performance steel, extremely resilient, yet thin-walled and ideal for working in confined spaces.

Technical Drawing.

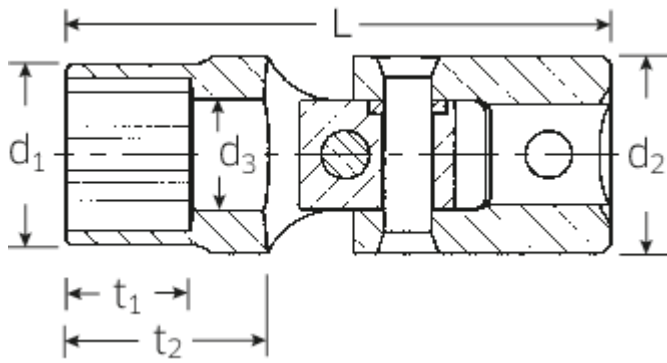

Technical Attributes.

Output profile	Spline-drive
Drive square internal (inch)	1/4"
Size Output profile	10
Length mm (L)	38 mm

Logistics data.

Length (IFS)	38
Width (IFS)	14
Height (IFS)	14
Length (packed, mm)	70
Width (packed, mm)	50
Height (packed, mm)	14
Volume (packed, mm)	0.049 dm ³
Code	01542020
Weight (gross, kg)	0,094
Weight PAP (kg)	0,000
Weight PVC (kg)	0,002
GTIN	4018754170883
Country of origin	GERMANY
Region of origin	Nordrhein-Westfalen
WEEE/Electrical Act	nicht ear-pflichtig
Customs tariff no.	82042000
Numbers of content units per order units	5
Weight	18 g

Variants.

Code	Article number (ERP)	Article description (Autom.)	GTIN
01542016	402ASP 8 =1/4	1/4" Uniflex sockets spline-drive L.32mm	4018754170876
01542020	402ASP 10 =5/16	1/4" Uniflex sockets spline-drive L.38mm	4018754170883

GTIN-Code.



STAHLWILLE Eduard Wille GmbH & Co. KG

Lindenallee 27 · 42349 Wuppertal · Germany · Phone: +49 202 4791-0 · Fax: +49 202 4791-200
info@stahlwille.de · www.stahlwille.de · Copyright by STAHLWILLE Eduard Wille GmbH & Co. KG, Wuppertal
Copyright by STAHLWILLE Eduard Wille GmbH & Co. KG, Wuppertal