

Adapter

447



Art.No. 02181010
GTIN 4018754141005
Model 447 10



Label. Adapter 10mm Inside square 3/8"

- Features.**
- HPQ® high performance steel, gunmetal finish
 - Caution! Modified settings on torque wrench <!-- (refer to note on page [170524]) -->

Advantages.

STAHLWILLE: For over 160 years, we as a traditional German company from Wuppertal have stood for tools that are appreciated around the world for their excellent quality

Technical Drawing.

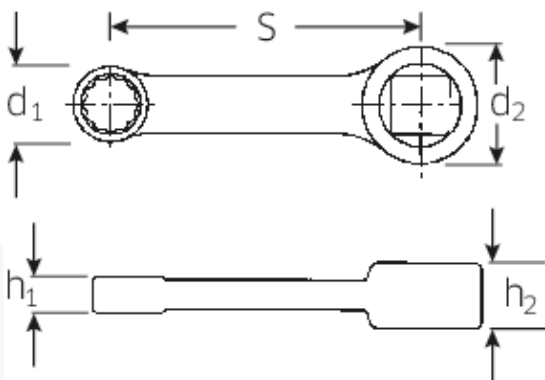

Technical Attributes.

d1	15,6 mm
d2	19 mm
Height mm (h1)	8 mm
Height mm (h2)	11 mm
Female square drive [inches]	3/8 "
S	50,8 mm
Size [mm]	10 mm

Logistics data.

Length (IFS)	68
Width (IFS)	19
Height (IFS)	11
Length (packed, mm)	105
Width (packed, mm)	25
Height (packed, mm)	12
Volume (packed, mm)	0.0315 dm ³
Code	02181010
Weight (gross, kg)	0,045
Weight PAP (kg)	0,000
Weight PVC (kg)	0,002
GTIN	4018754141005
Country of origin	GERMANY
Region of origin	Nordrhein-Westfalen
WEEE/Electrical Act	nicht ear-pflichtig
Customs tariff no.	82042000
Numbers of content units per order units	1
Weight	40 g

Variants.

Code	Article number (ERP)	Article description (Autom._)	GTIN
02181007	447 7	Adapter 7mm Inside square 3/8"	4018754139125
02181008	447 8	Adapter 8mm Inside square 3/8"	4018754139132
02181009	447 9	Adapter 9mm Inside square 3/8"	4018754140992
02181010	447 10	Adapter 10mm Inside square 3/8"	4018754141005
02181013	447 13	Adapter 13mm Inside square 3/8"	4018754141012

GTIN-Code.





STAHLWILLE Eduard Wille GmbH & Co. KG

Lindenallee 27 · 42349 Wuppertal · Germany · Phone: +49 202 4791-0 · Fax: +49 202 4791-200
info@stahlwille.de · www.stahlwille.de · Copyright by STAHLWILLE Eduard Wille GmbH & Co. KG, Wuppertal
Copyright by STAHLWILLE Eduard Wille GmbH & Co. KG, Wuppertal