



Screwdriver socket

44P

Art.No. 01290001
GTIN 4018754001040
Model 44 P 1
SCHRAUBENDREHEREINSATZ 1/4
ZOLL

Label. 1/4" Screwdriver socket PH1 L.28mm

Features.

- for recessed head screws Phillips-Recess®
- tips to DIN 5260
- Chrome Alloy Steel, chrome plated

Advantages.

For Phillips-Recess® cross-slot screws

STAHLWILLE: For over 160 years, we as a traditional German company from Wuppertal have stood for tools that are appreciated around the world for their excellent quality

Technical Drawing.

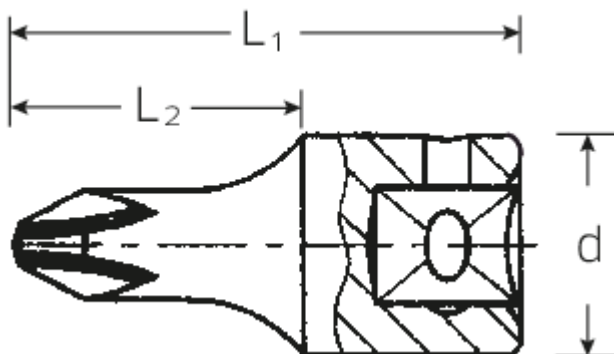

Technical Attributes.

Output profile	Phillips-Recess®
Drive square internal (inch)	1/4"
d	11,6 mm
Size Output profile	PH1
L1	28 mm
L2	16 mm

Logistics data.

Length (IFS)	28
Width (IFS)	12
Height (IFS)	12
Length (packed, mm)	65
Width (packed, mm)	35
Height (packed, mm)	15
Volume (packed, mm)	0.034125 dm3
Code	01290001
Weight (gross, kg)	0,063
Weight PAP (kg)	0,000
Weight PVC (kg)	0,002
GTIN	4018754001040
Country of origin	GERMANY
Region of origin	Nordrhein-Westfalen
WEEE/Electrical Act	nicht ear-pflichtig
Customs tariff no.	82042000
Numbers of content units per order units	5
Weight	12 g

Variants.

Code	Article number (ERP)	Article description (Autom.)	GTIN
01290001	44 P 1 SCHRAUBENDREHEREINSATZ 1/4 ZOLL	1/4" Screwdriver socket PH1 L.28mm	4018754001040
01290002	44 P 2 SCHRAUBENDREHEREINSATZ 1/4 ZOLL	1/4" Screwdriver socket PH2 L.28mm	4018754001057
01290003	44 P 3 SCHRAUBENDREHEREINSATZ 1/4 ZOLL	1/4" Screwdriver socket PH3 L.28mm	4018754001064
01290004	44 P 4 SCHRAUBENDREHEREINSATZ 1/4 ZOLL	1/4" Screwdriver socket PH4 L.28mm	4018754001071

GTIN-Code.



STAHLWILLE Eduard Wille GmbH & Co. KG

Lindenallee 27 · 42349 Wuppertal · Germany · Phone: +49 202 4791-0 · Fax: +49 202 4791-200
info@stahlwille.de · www.stahlwille.com · Copyright by STAHLWILLE Eduard Wille GmbH & Co. KG, Wuppertal
Copyright by STAHLWILLE Eduard Wille GmbH & Co. KG, Wuppertal