



VDE screwdriver socket

12174 VDE



Art.No. 02390020
GTIN 4018754253593
Model 12174 VDE T 20

Label. 3/8" VDE screwdriver socket L.67mm

- Features.**
- for internal TORX® screws
 - Chrome-Alloy-Steel, chrome plated
 - VDE insulated up to 1000 V
 - DIN EN 60900
 - #T; AC/1000 V

Advantages.

For recessed TORX® screws

STAHLWILLE: For over 160 years, we as a traditional German company from Wuppertal have stood for tools that are appreciated around the world for their excellent quality

Technical Drawing.

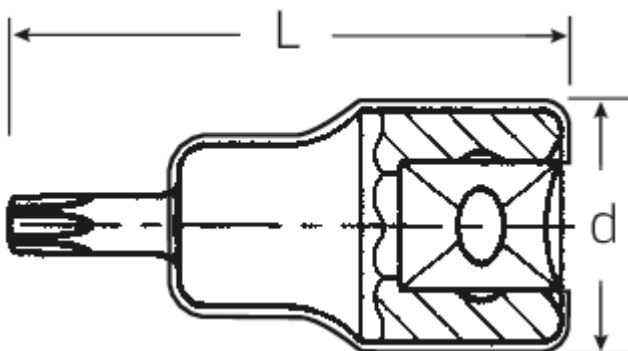

Technical Attributes.

Output profile	TORX®
Drive square internal (inch)	3/8"
d	22,8 mm
Size Output profile	T20
Length mm (L)	67 mm

Logistics data.

Length (IFS)	66
Width (IFS)	19
Height (IFS)	19
Length (packed, mm)	75
Width (packed, mm)	35
Height (packed, mm)	35
Volume (packed, mm)	0.091875 dm ³
Code	02390020
Weight (gross, kg)	0,055
Weight PAP (kg)	0,000
Weight PVC (kg)	0,002
GTIN	4018754253593
Country of origin	GERMANY
Region of origin	Nordrhein-Westfalen
WEEE/Electrical Act	nicht ear-pflichtig
Customs tariff no.	82042000
Numbers of content units per order units	1
Weight	52 g

Variants.

Code	Article number (ERP)	Article description (Autom._)	GTIN
02390020	12174 VDE T 20	3/8" VDE screwdriver socket L.67mm	4018754253593
02390025	12174 VDE T 25	3/8" VDE screwdriver socket L.67mm	4018754253609
02390030	12174 VDE T 30	3/8" VDE screwdriver socket L.67mm	4018754253616
02390040	12174 VDE T 40	3/8" VDE screwdriver socket L.67mm	4018754253623
02390045	12174 VDE T 45	3/8" VDE screwdriver socket L.67mm	4018754253630

GTIN-Code.





STAHLWILLE Eduard Wille GmbH & Co. KG

Lindenallee 27 · 42349 Wuppertal · Germany · Phone: +49 202 4791-0 · Fax: +49 202 4791-200
info@stahlwille.de · www.stahlwille.com · Copyright by STAHLWILLE Eduard Wille GmbH & Co. KG, Wuppertal
Copyright by STAHLWILLE Eduard Wille GmbH & Co. KG, Wuppertal