



UNIFLEX socket

53

Art.No. **03040010**
GTIN **4018754006151**
Model **53 10**



Label. 1/2" UNIFLEX socket size 10mm L.70mm

Features.

- Chrome Alloy Steel, chrome plated

Advantages.

STAHLWILLE: For over 160 years, we as a traditional German company from Wuppertal have stood for tools that are appreciated around the world for their excellent quality

Technologies and features.



High Performance Quality (HPQ®)

High-performance steel, extremely resilient, yet thin-walled and ideal for working in confined spaces.

Technical Drawing.

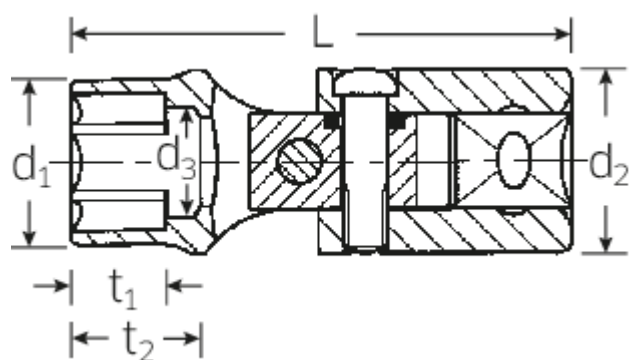

Technical Attributes.

Output profile	Hexagon AS drive
Drive square internal (inch)	1/2"
d1	14,7 mm
d2	25 mm
d3	9 mm
Length mm (L)	70 mm
Size [mm]	10 mm
t2	20 mm

Logistics data.

Length (IFS)	70
Width (IFS)	25
Height (IFS)	25
Length (packed, mm)	70
Width (packed, mm)	25
Height (packed, mm)	25
Volume (packed, mm)	0.04375 dm ³
Code	03040010
Weight (gross, kg)	0,139
Weight PAP (kg)	0,000
Weight PVC (kg)	0,002
GTIN	4018754006151
Country of origin	GERMANY
Region of origin	Nordrhein-Westfalen
WEEE/Electrical Act	nicht ear-pflichtig
Customs tariff no.	82042000
Numbers of content units per order units	1
Weight	136 g

Variants.

Code	Article number (ERP)	Article description (Autom._)	GTIN
03040010	53 10	1/2" UNIFLEX socket size 10mm L.70mm	4018754006151
03040013	53 13	1/2" UNIFLEX socket size 13mm L.70mm	4018754006175

03040016	53 16	1/2" UNIFLEX socket size 16mm L.69mm	4018754006199
03040017	53 17	1/2" UNIFLEX socket size 17mm L.70mm	4018754006205
03040018	53 18	1/2" UNIFLEX socket size 18mm L.70mm	4018754006212
03040019	53 19	1/2" UNIFLEX socket size 19mm L.70mm	4018754006229

GTIN-Code.



STAHLWILLE Eduard Wille GmbH & Co. KG

Lindenallee 27 · 42349 Wuppertal · Germany · Phone: +49 202 4791-0 · Fax: +49 202 4791-200
info@stahlwille.de · www.stahlwille.com · Copyright by STAHLWILLE Eduard Wille GmbH & Co. KG, Wuppertal
Copyright by STAHLWILLE Eduard Wille GmbH & Co. KG, Wuppertal