

Screwdriver socket

49TX



Art.No. 02100020
GTIN 4018754002832
Model 49 TX T 20

Label. 3/8" Screwdriver socket L.49mm

Features.

- for inside TORX® screws
- Chrome Alloy Steel, chrome plated

Advantages.

For recessed TORX® screws

STAHLWILLE: For over 160 years, we as a traditional German company from Wuppertal have stood for tools that are appreciated around the world for their excellent quality

Technical Drawing.

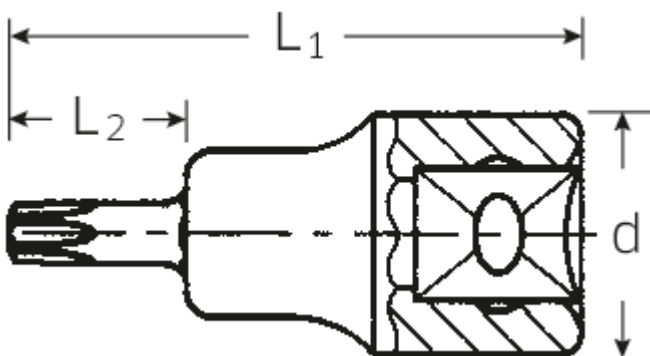

Technical Attributes.

Output profile	TORX®
Drive square internal (inch)	3/8"
d	17,8 mm
Size Output profile	T20
L1	49 mm
L2	17 mm
Length mm (L)	50 mm

Logistics data.

Length (IFS)	50
Width (IFS)	18
Height (IFS)	18
Length (packed, mm)	80
Width (packed, mm)	40
Height (packed, mm)	35
Volume (packed, mm)	0.112 dm ³
Code	02100020
Weight (gross, kg)	0,230
Weight PAP (kg)	0,000
Weight PVC (kg)	0,002
GTIN	4018754002832
Country of origin	GERMANY
Region of origin	Nordrhein-Westfalen
WEEE/Electrical Act	nicht ear-pflichtig
Customs tariff no.	82042000
Numbers of content units per order units	5
Weight	46 g

Variants.

Code	Article number (ERP)	Article description (Autom._)	GTIN
02100009	49 TX T 9	3/8" Screwdriver socket L.49mm	4018754002801
02100010	49 TX T 10	3/8" Screwdriver socket L.49mm	4018754002818
02100015	49 TX T 15	3/8" Screwdriver socket L.49mm	4018754002825
02100020	49 TX T 20	3/8" Screwdriver socket L.49mm	4018754002832
02100025	49 TX T 25	3/8" Screwdriver socket L.49mm	4018754002849
02100027	49 TX T 27	3/8" Screwdriver socket L.49mm	4018754002856
02100030	49 TX T 30	3/8" Screwdriver socket L.49mm	4018754002863
02100040	49 TX T 40	3/8" Screwdriver socket L.49mm	4018754002870
02100045	49 TX T 45	3/8" Screwdriver socket L.49mm	4018754139378

GTIN-Code.



STAHLWILLE Eduard Wille GmbH & Co. KG

Lindenallee 27 · 42349 Wuppertal · Germany · Phone: +49 202 4791-0 · Fax: +49 202 4791-200
info@stahlwille.de · www.stahlwille.com · Copyright by STAHLWILLE Eduard Wille GmbH & Co. KG, Wuppertal
Copyright by STAHLWILLE Eduard Wille GmbH & Co. KG, Wuppertal