

INHEX socket

59



Art.No. **05050014**
GTIN **4018754009282**
Model **59 14**

Label. INHEX socket 3/4" 14mm L.80mm

Features.

- for socket head screws
- DIN 7422
- Chrome Alloy Steel, chrome plated

Advantages.

For Allen screws

STAHLWILLE: For over 160 years, we as a traditional German company from Wuppertal have stood for tools that are appreciated around the world for their excellent quality

Technical Drawing.

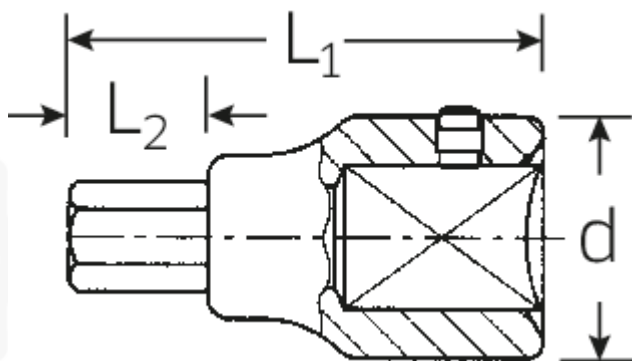

Technical Attributes.

Output profile	Hex
Output hex. outside (mm)	14 mm
Drive square internal (inch)	3/4"
d	34,7 mm
L1	80 mm
L2	25 mm

Logistics data.

Length (IFS)	80
Width (IFS)	35
Height (IFS)	35
Length (packed, mm)	80
Width (packed, mm)	35
Height (packed, mm)	35
Volume (packed, mm)	0.098 dm ³
Code	05050014
Weight (gross, kg)	0,280
Weight PAP (kg)	0,000
Weight PVC (kg)	0,003
GTIN	4018754009282
Country of origin	GERMANY
Region of origin	Nordrhein-Westfalen
WEEE/Electrical Act	nicht ear-pflichtig
Customs tariff no.	82042000
Numbers of content units per order units	1
Weight	272 g

Variants.

Code	Article number (ERP)	Article description (Autom._)	GTIN
05050014	59 14	INHEX socket 3/4" 14mm L.80mm	4018754009282
05050017	59 17	INHEX socket 3/4" 17mm L.80mm	4018754009299
05050019	59 19	INHEX socket 3/4" 19mm L.80mm	4018754009305
05050022	59 22	INHEX socket 3/4" 22mm L.80mm	4018754132164

GTIN-Code.





STAHLWILLE Eduard Wille GmbH & Co. KG

Lindenallee 27 · 42349 Wuppertal · Germany · Phone: +49 202 4791-0 · Fax: +49 202 4791-200
info@stahlwille.de · www.stahlwille.com · Copyright by STAHLWILLE Eduard Wille GmbH & Co. KG, Wuppertal
Copyright by STAHLWILLE Eduard Wille GmbH & Co. KG, Wuppertal