

Screwdriver socket

49X



Art.No. 02060006
GTIN 4018754002689
Model 49 X M 6

Label. 3/8" Screwdriver socket L.52mm

Features.

- for tri-square socket head screws (XZN®)
- DIN 2324
- Chrome Alloy Steel, chrome plated

Advantages.

For spline socket head screws (XZN®)

STAHLWILLE: For over 160 years, we as a traditional German company from Wuppertal have stood for tools that are appreciated around the world for their excellent quality

Technical Drawing.

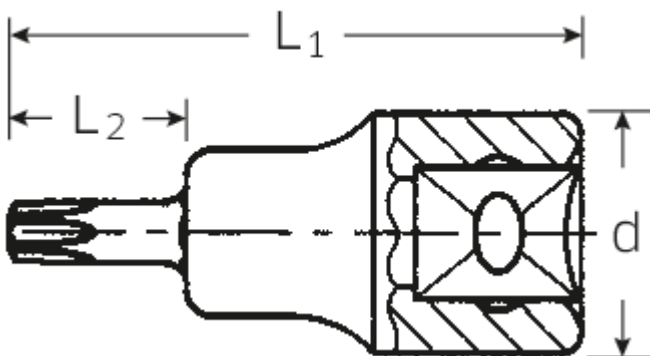

Technical Attributes.

Drive square internal (inch)	3/8"
d	17,8 mm
Size Output profile	M6
L1	52 mm
L2	20 mm
Length mm (L)	52 mm

Logistics data.

Length (IFS)	52
Width (IFS)	18
Height (IFS)	18
Length (packed, mm)	70
Width (packed, mm)	62
Height (packed, mm)	19
Volume (packed, mm)	0.08246 dm ³
Code	02060006
Weight (gross, kg)	0,241
Weight PAP (kg)	0,000
Weight PVC (kg)	0,003
GTIN	4018754002689
Country of origin	GERMANY
Region of origin	Nordrhein-Westfalen
WEEE/Electrical Act	nicht ear-pflichtig
Customs tariff no.	82042000
Numbers of content units per order units	5
Weight	47 g

Variants.

Code	Article number (ERP)	Article description (Autom._)	GTIN
02060005	49 X M 5	3/8" Screwdriver socket L.52mm	4018754002672
02060006	49 X M 6	3/8" Screwdriver socket L.52mm	4018754002689
02060008	49 X M 8	3/8" Screwdriver socket L.52mm	4018754002696
02060010	49 X M 10	3/8" Screwdriver socket L.52mm	4018754002702

GTIN-Code.





STAHLWILLE Eduard Wille GmbH & Co. KG

Lindenallee 27 · 42349 Wuppertal · Germany · Phone: +49 202 4791-0 · Fax: +49 202 4791-200
info@stahlwille.de · www.stahlwille.com · Copyright by STAHLWILLE Eduard Wille GmbH & Co. KG, Wuppertal
Copyright by STAHLWILLE Eduard Wille GmbH & Co. KG, Wuppertal