

## Screwdriver socket

49X



Art.No. 02060005  
GTIN 4018754002672  
Model 49 X M 5

**Label.** 3/8" Screwdriver socket L.52mm

**Features.**

- for tri-square socket head screws (XZN®)
- DIN 2324
- Chrome Alloy Steel, chrome plated

## Advantages.

For spline socket head screws (XZN®)

STAHLWILLE: For over 160 years, we as a traditional German company from Wuppertal have stood for tools that are appreciated around the world for their excellent quality

## Technical Drawing.

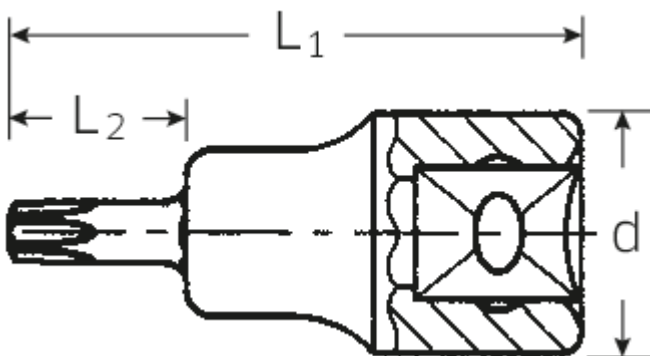

## Technical Attributes.

Drive square internal (inch)	3/8"
d	17,8 mm
Size Output profile	M5
L1	52 mm
L2	20 mm
Length mm (L)	52 mm

## Logistics data.

Length (IFS)	52
Width (IFS)	18
Height (IFS)	18
Length (packed, mm)	70
Width (packed, mm)	62
Height (packed, mm)	19
Volume (packed, mm)	0.08246 dm <sup>3</sup>
Code	02060005
Weight (gross, kg)	0,231
Weight PAP (kg)	0,000
Weight PVC (kg)	0,003
GTIN	4018754002672
Country of origin	GERMANY
Region of origin	Nordrhein-Westfalen
WEEE/Electrical Act	nicht ear-pflichtig
Customs tariff no.	82042000
Numbers of content units per order units	5
Weight	45 g

## Variants.

Code	Article number (ERP)	Article description (Autom._)	GTIN
02060005	49 X M 5	3/8" Screwdriver socket L.52mm	4018754002672
02060006	49 X M 6	3/8" Screwdriver socket L.52mm	4018754002689
02060008	49 X M 8	3/8" Screwdriver socket L.52mm	4018754002696
02060010	49 X M 10	3/8" Screwdriver socket L.52mm	4018754002702

## GTIN-Code.





**STAHLWILLE Eduard Wille GmbH & Co. KG**

Lindenallee 27 · 42349 Wuppertal · Germany · Phone: +49 202 4791-0 · Fax: +49 202 4791-200  
info@stahlwille.de · www.stahlwille.com · Copyright by STAHLWILLE Eduard Wille GmbH & Co. KG, Wuppertal  
Copyright by STAHLWILLE Eduard Wille GmbH & Co. KG, Wuppertal